

GENERAL DETAILS

- 2: SYSTEM ISOMETRIC
- 3: ATTACHMENT EXTRUSIONS

SECTION DETAILS

- 4: BASE
- 5A-B: TYPICAL VERTICAL
- 6: WINDOW SILL
- 7A-B: PARAPET
- 8A-B: INSIDE CORNER
- 9: OUTSIDE CORNER
- 10A. VERTICAL JAMB - START
- 10B. VERTICAL JAMB - END
- 11. TYPICAL HORIZONTAL
- 12. DIFFERENT DEPTH VERTICAL DETAIL
- 13. DIFFERENT DEPTH HORIZONTAL DETAIL
- 14. DIFFERENT DEPTH VERTICAL DETAIL
- 15. DIFFERENT DEPTH HORIZONTAL DETAIL
- 16. DISSIMILAR METALS - JAMB
- 17. DISSIMILAR METALS - SILL
- 18. TYPICAL SOFFIT DETAIL
- 19. SOFFIT TO WALL

\*TESTING PERFORMED ON STANDARD SYSTEM DEPTH ONLY. INQUIRE IF ADDITIONAL TESTING IS REQUIRED.

Sheet  <b>1</b>	Drawn By NCDS	Project Number  <b>DWG-01</b>	Project	<b>ARROWHEAD RAINSCREEN PANEL SYSTEM ELEVATION</b>	N\FairView\Refs\Fairview_Logo.JPG
	Date Drawn 2/2/2018		<b>ARROWHEAD RAINSCREEN PANEL SYSTEM ELEVATION</b>		N\FairView\Refs\Arrowhead_Logo.png
	Revisions No. _____ Date _____ No. _____ Date _____		© Copyright Fairview Architectural LLC - Patented and/or Patent Pending		www.fairview-na.com

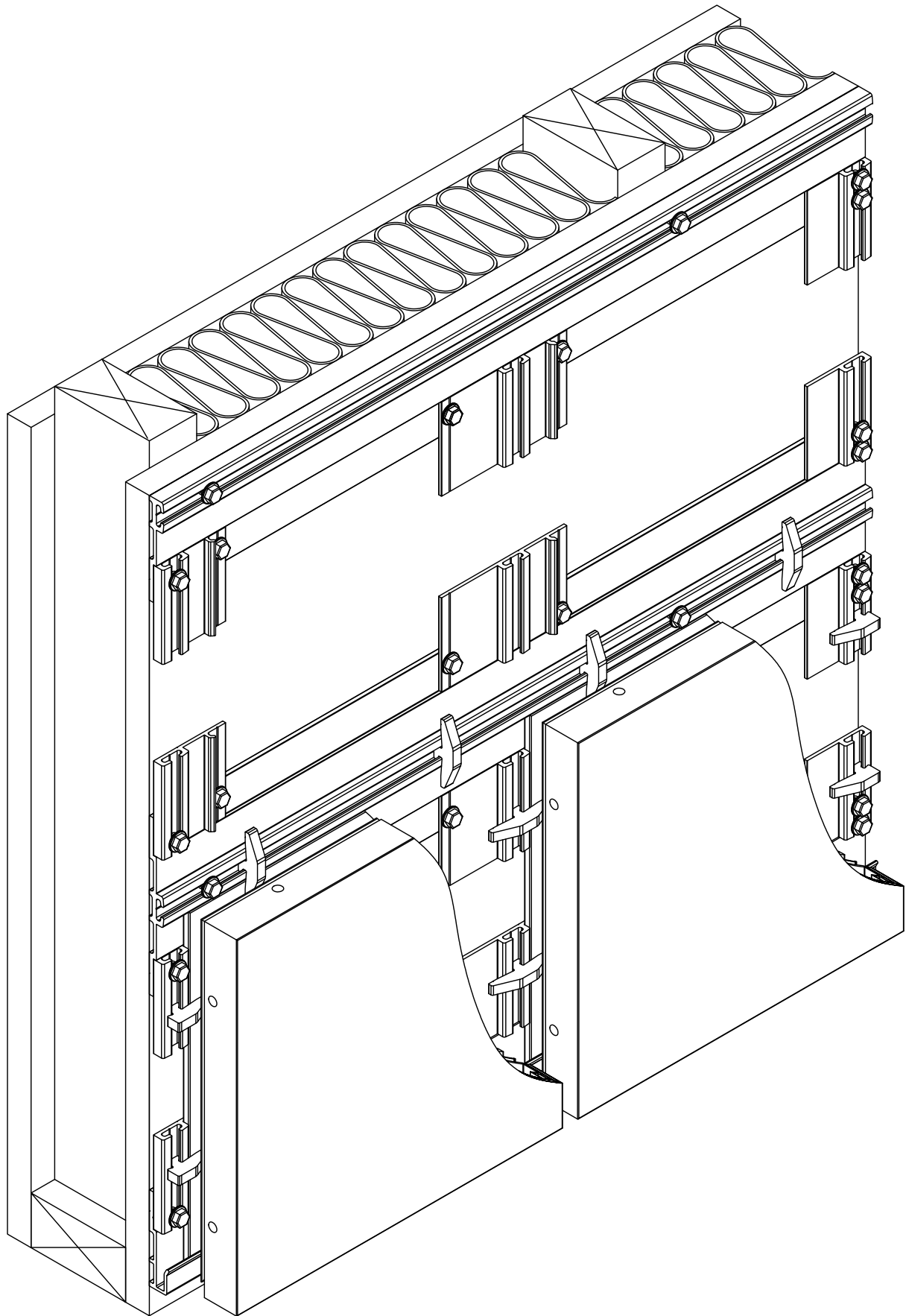

Sheet  
2

Drawn By  
NCDS  
Date Drawn  
2/2/2018  
Revisions  
No. \_\_\_\_\_ Date \_\_\_\_\_  
No. \_\_\_\_\_ Date \_\_\_\_\_

Project Number  
DWG-01

Project  
**ARROWHEAD RAINSCREEN PANEL SYSTEM  
SYSTEM ISOMETRIC**  
© Copyright Fairview Architectural LLC - Patented and/or Patent Pending

N\FairView\Refs\Fairview\_Logo.JPG  
N\FairView\Refs\Arrowhead\_Logo.png  
www.fairview-na.com

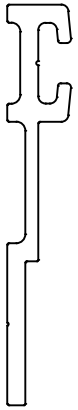

AH-203 HEAD

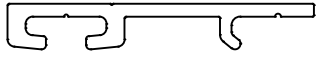

AH-207 STARTER CLIP



AH-204 VERTICAL CLIP

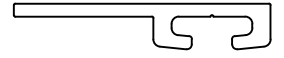

AH-206 END CLIP

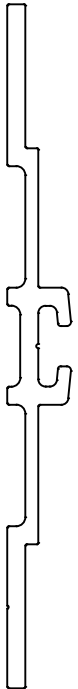

AH-202 BASE

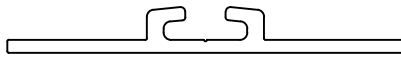

AH-102 BASE

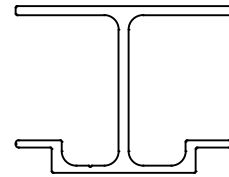

AH-106 STIFFENER

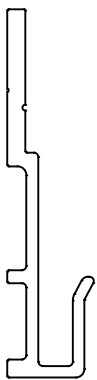

AH-205 SILL



AH-104 T-CLIP



AH-107 PERIMETER CLIP

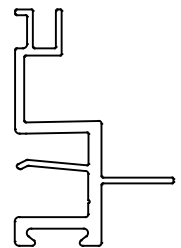

AH-101 FRAME

Sheet <b>3</b>	Drawn By NCDS	Project Number  <b>DWG-01</b>	Project	N\FairView\Refs\Fairview_Logo.JPG  N\FairView\Refs\Arrowhead_Logo.png  www.fairview-na.com
	Date Drawn 2/2/2018		<b>ARROWHEAD RAINSCREEN PANEL SYSTEM ATTACHMENT EXTRUSIONS</b>	
	Revisions No. _____ Date _____ No. _____ Date _____		© Copyright Fairview Architectural LLC - Patented and/or Patent Pending	

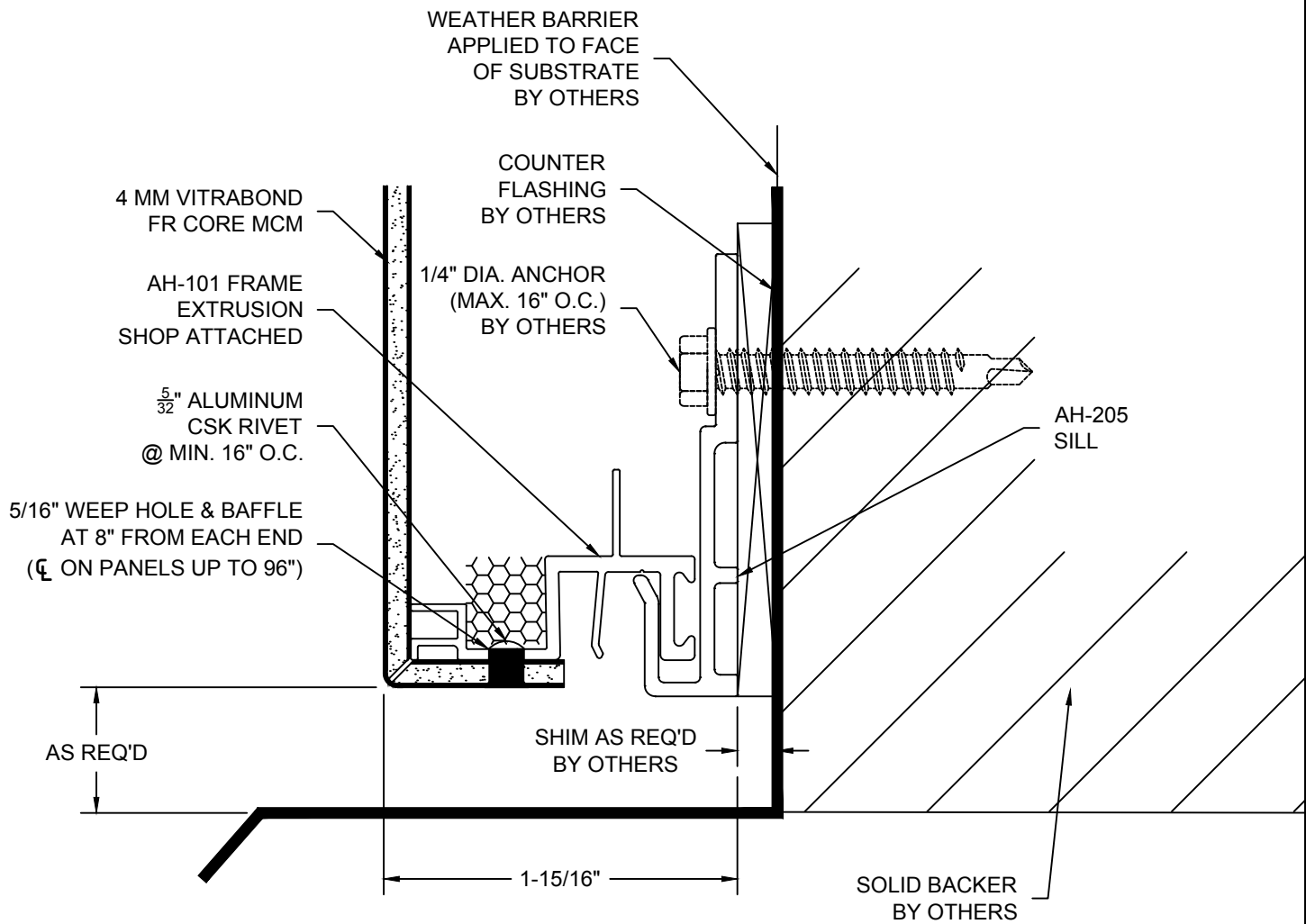

Sheet <b>4</b>	Drawn By NCDS	Project Number  <b>DWG-01</b>	Project	N\FairView\Refs\Fairview_Logo.JPG  N\FairView\Refs\Arrowhead_Logo.png  www.fairview-na.com
	Date Drawn 2/2/2018		<b>ARROWHEAD RAINSCREEN PANEL SYSTEM BASE DETAIL</b>	
	Revisions No. _____ Date _____ No. _____ Date _____		© Copyright Fairview Architectural LLC - Patented and/or Patent Pending	

IF SELF TAPPING SCREWS  
PENETRATE WEATHER  
BARRIER, THESE LOCATIONS  
MUST BE SEALED

#12 X 3/4" SELF DRILLING TEK  
SCREWS MAY BE USED WITH  
EXTERIOR INSULATED WALLS

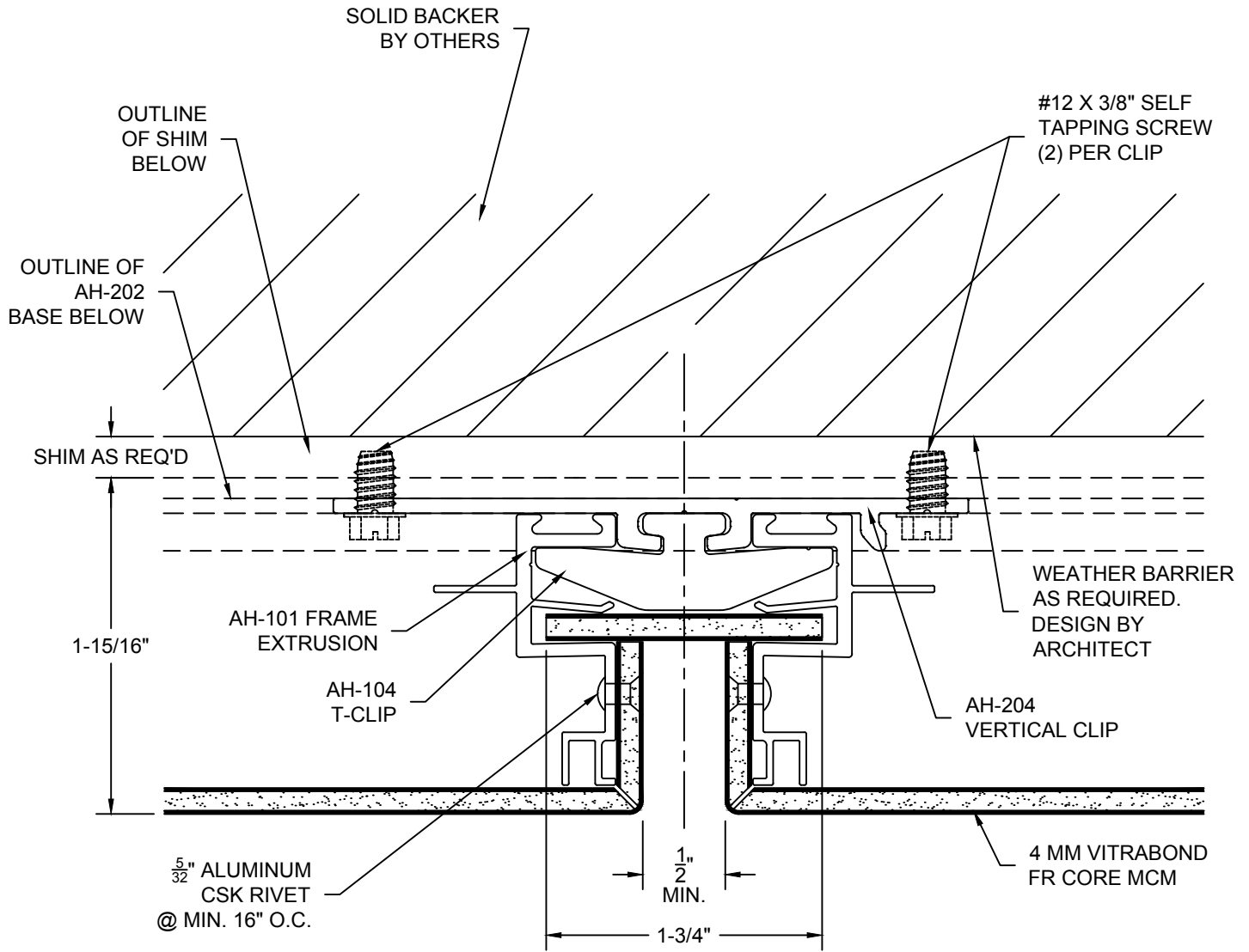

Sheet <b>5A</b>	Drawn By NCDS	Project Number  <b>DWG-01</b>	Project	N\FairView\Refs\Fairview_Logo.JPG  N\FairView\Refs\Arrowhead_Logo.png  www.fairview-na.com	
	Date Drawn 2/2/2018		<b>ARROWHEAD RAINSCREEN PANEL SYSTEM</b> <b>TYPICAL VERTICAL DETAIL</b>		
	Revisions No. _____ Date _____ No. _____ Date _____		© Copyright Fairview Architectural LLC - Patented and/or Patent Pending		

IF SELF TAPPING SCREWS  
PENETRATE WEATHER  
BARRIER, THESE LOCATIONS  
MUST BE SEALED

#12 X 3/4" SELF DRILLING TEK  
SCREWS MAY BE USED WITH  
EXTERIOR INSULATED WALLS

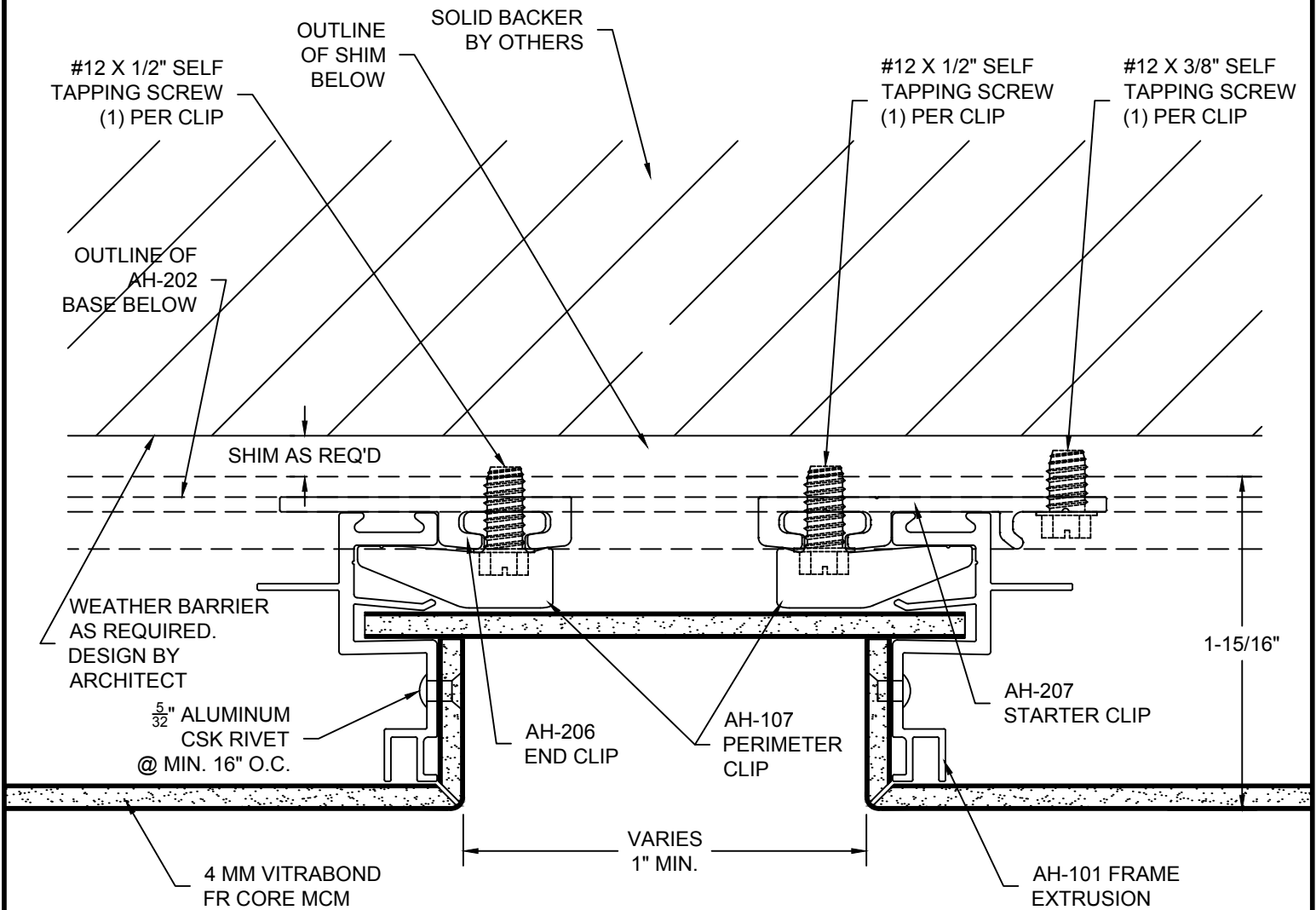

Sheet <b>5B</b>	Drawn By NCDS	Project Number  <b>DWG-01</b>	Project	N:\FairView\Refs\Fairview_Logo.JPG  N:\FairView\Refs\Arrowhead_Logo.png  www.fairview-na.com	
	Date Drawn 2/2/2018		<b>ARROWHEAD RAINSCREEN PANEL SYSTEM ALT. HORIZ/VERTICAL DETAIL</b>		
	Revisions No. _____ Date _____ No. _____ Date _____		© Copyright Fairview Architectural LLC - Patented and/or Patent Pending		

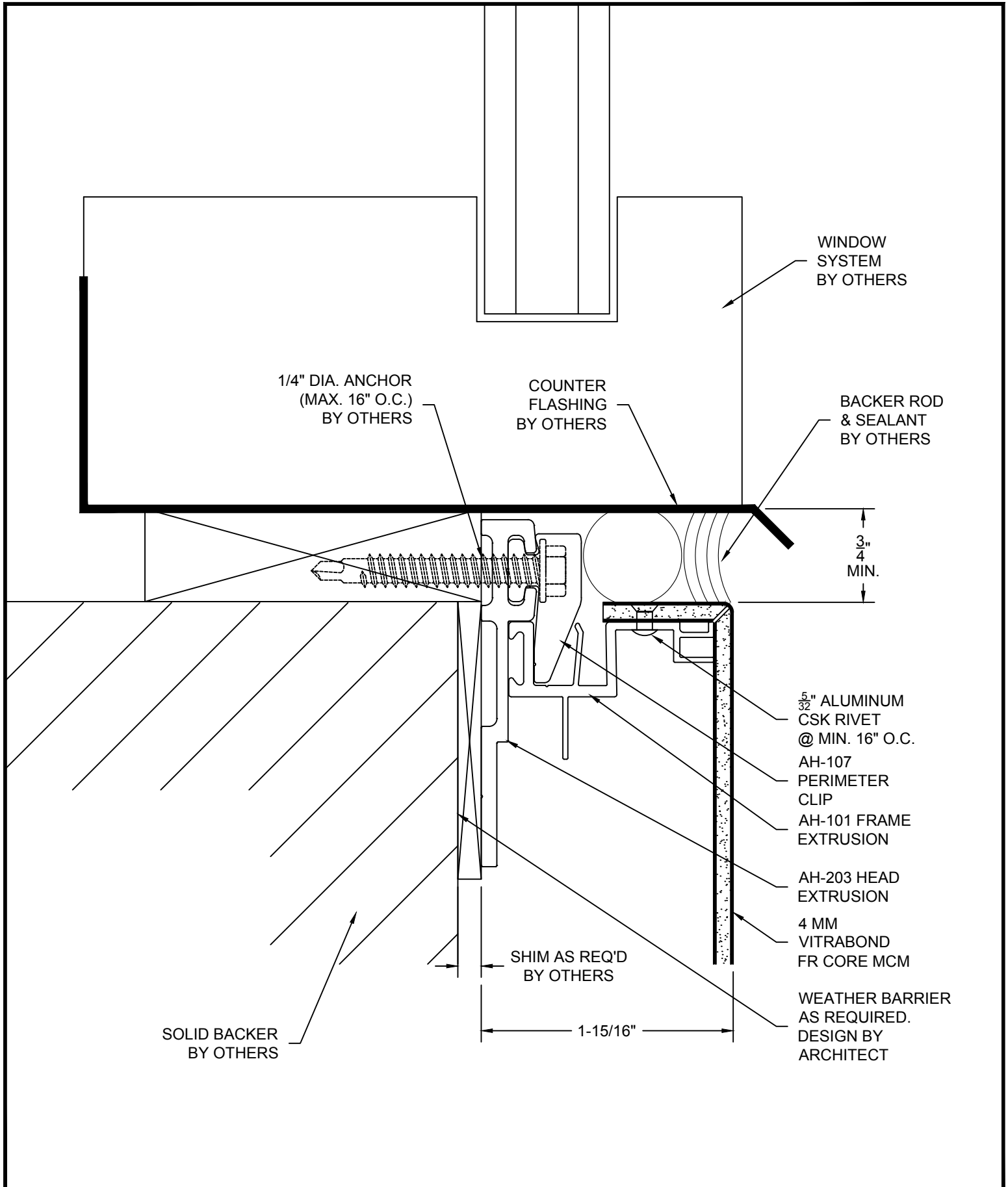

Sheet  <b>6</b>	Drawn By <b>NCDS</b>	Project Number  <b>DWG-01</b>	Project  <b>ARROWHEAD RAINSCREEN PANEL SYSTEM DISSIMILAR METALS</b>	<small>N\FairView\Refs\Fairview_Logo.JPG</small>
	Date Drawn 2/2/2018		© Copyright Fairview Architectural LLC - Patented and/or Patent Pending	<small>N\FairView\Refs\Arrowhead_Logo.png</small>
	Revisions No. _____ Date _____ No. _____ Date _____		www.fairview-na.com	

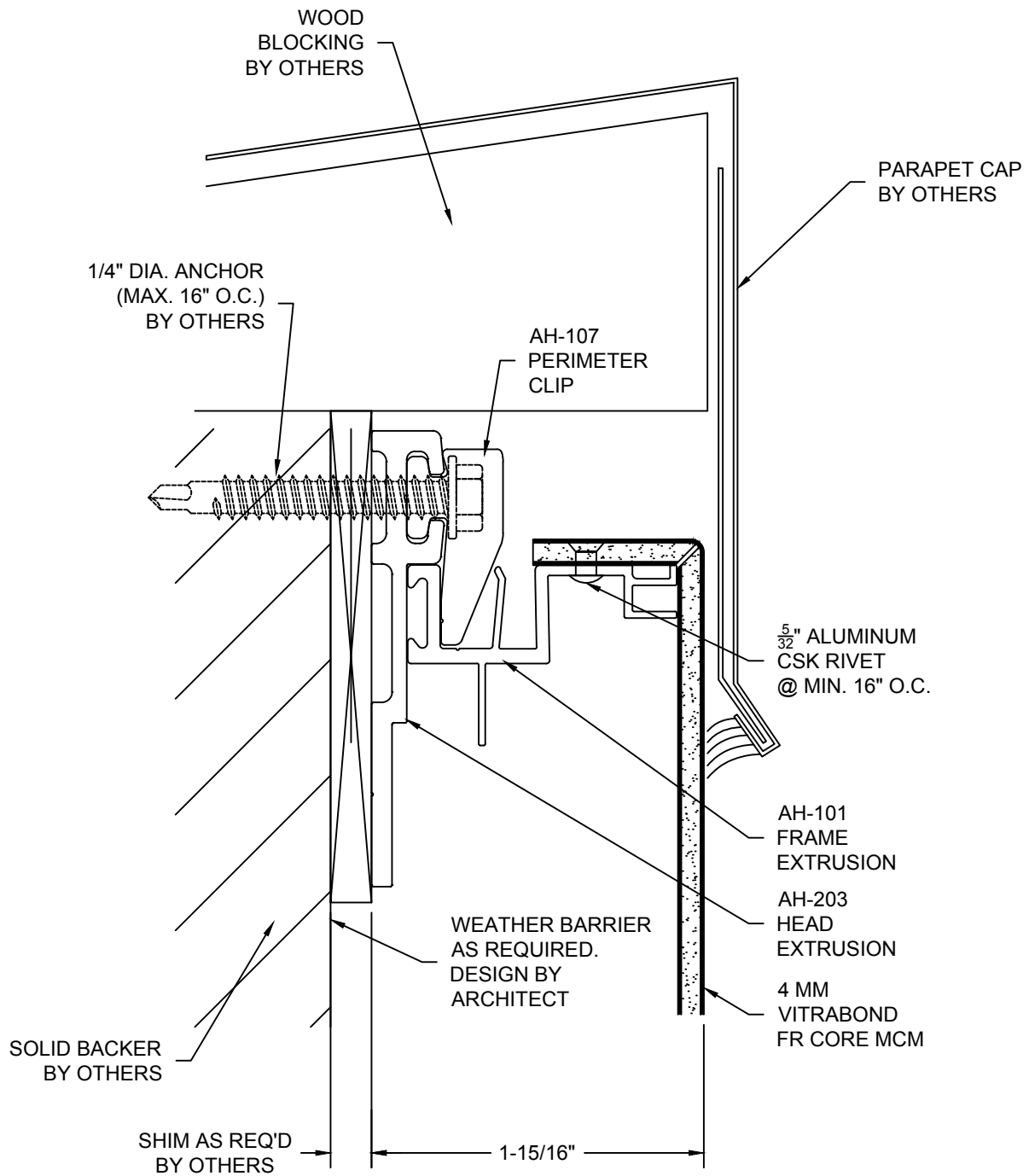

Sheet <b>7A</b>	Drawn By NCDS	Project Number  <b>DWG-01</b>	Project	<b>ARROWHEAD RAINSCREEN PANEL SYSTEM PARAPET DETAIL</b>  © Copyright Fairview Architectural LLC - Patented and/or Patent Pending  <a href="http://www.fairview-na.com">www.fairview-na.com</a>	N\FairView\Refs\Fairview_Logo.JPG
	Date Drawn 2/2/2018				N\FairView\Refs\Arrowhead_Logo.png
	Revisions No. _____ Date _____ No. _____ Date _____				



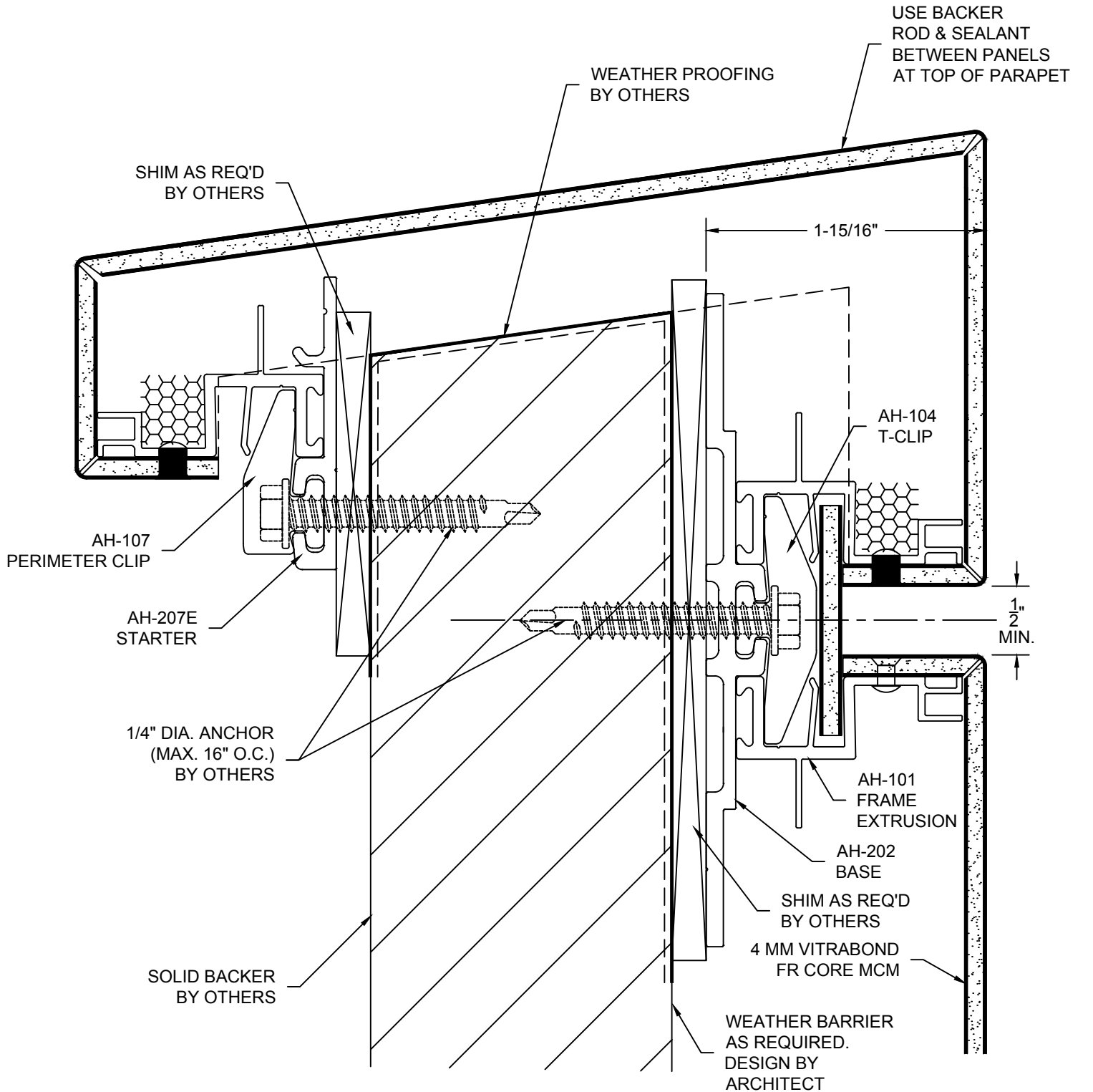

Sheet  
**7B**

Drawn By  
NCDS

Date Drawn  
2/2/2018

Revisions

No. \_\_\_\_\_ Date \_\_\_\_\_

No. \_\_\_\_\_ Date \_\_\_\_\_

Project Number  
**DWG-01**

Project  
**ARROWHEAD RAINSCREEN PANEL SYSTEM  
PARAPET DETAIL**

© Copyright Fairview Architectural LLC - Patented and/or Patent Pending

N:\FairView\Refs\Fairview\_Logo.JPG

N:\FairView\Refs\Arrowhead\_Logo.png

www.fairview-na.com

IF SELF TAPPING SCREWS  
PENETRATE WEATHER  
BARRIER, THESE LOCATIONS  
MUST BE SEALED

#12 X 3/4" SELF DRILLING TEK  
SCREWS MAY BE USED WITH  
EXTERIOR INSULATED WALLS

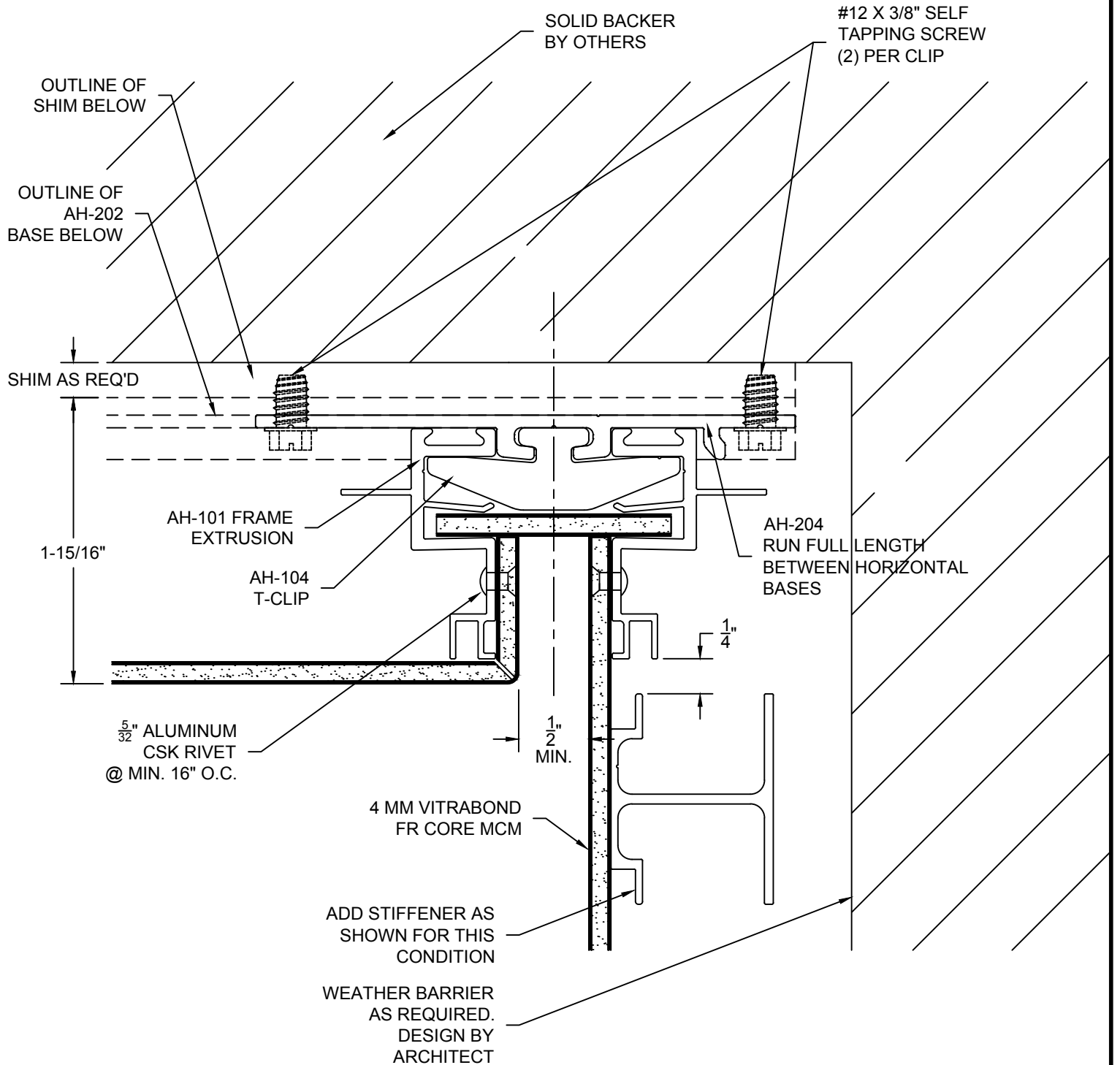

Sheet <b>8</b>	Drawn By NCDS	Project Number  <b>DWG-01</b>	Project	ARROWHEAD RAINSCREEN PANEL SYSTEM INSIDE CORNER DETAIL  © Copyright Fairview Architectural LLC - Patented and/or Patent Pending	N\FairView\Refs\Fairview_Logo.JPG
	Date Drawn 2/2/2018				N\FairView\Refs\Arrowhead_Logo.png
	Revisions No. _____ Date _____ No. _____ Date _____				www.fairview-na.com

IF SELF TAPPING SCREWS PENETRATE WEATHER BARRIER, THESE LOCATIONS MUST BE SEALED

#12 X 3/4" SELF DRILLING TEK SCREWS MAY BE USED WITH EXTERIOR INSULATED WALLS

SOLID BACKER BY OTHERS

#12 X 3/8" SELF TAPPING SCREW (2) PER CLIP

AH-204 AT CORNERS TO RUN FULL LENGTH BETWEEN HORIZONTAL BASES

SHIM AS REQ'D

AH-104 T-CLIP

1/2" MIN.

#12 X 1/2" SELF TAPPING SCREW (1) PER CLIP

AH-102 TO RUN FULL LENGTH BETWEEN HORIZONTAL BASES

5/32" ALUMINUM CSK RIVET @ MIN. 16" O.C.

1-15/16"

OUTLINE OF AH-202 BASE BELOW

OUTLINE OF SHIM BELOW

WEATHER BARRIER AS REQUIRED. DESIGN BY ARCHITECT

AH-104 T-CLIP  
AH-101 FRAME EXTRUSION

4 MM VITRABOND FR CORE MCM

1/2" MIN

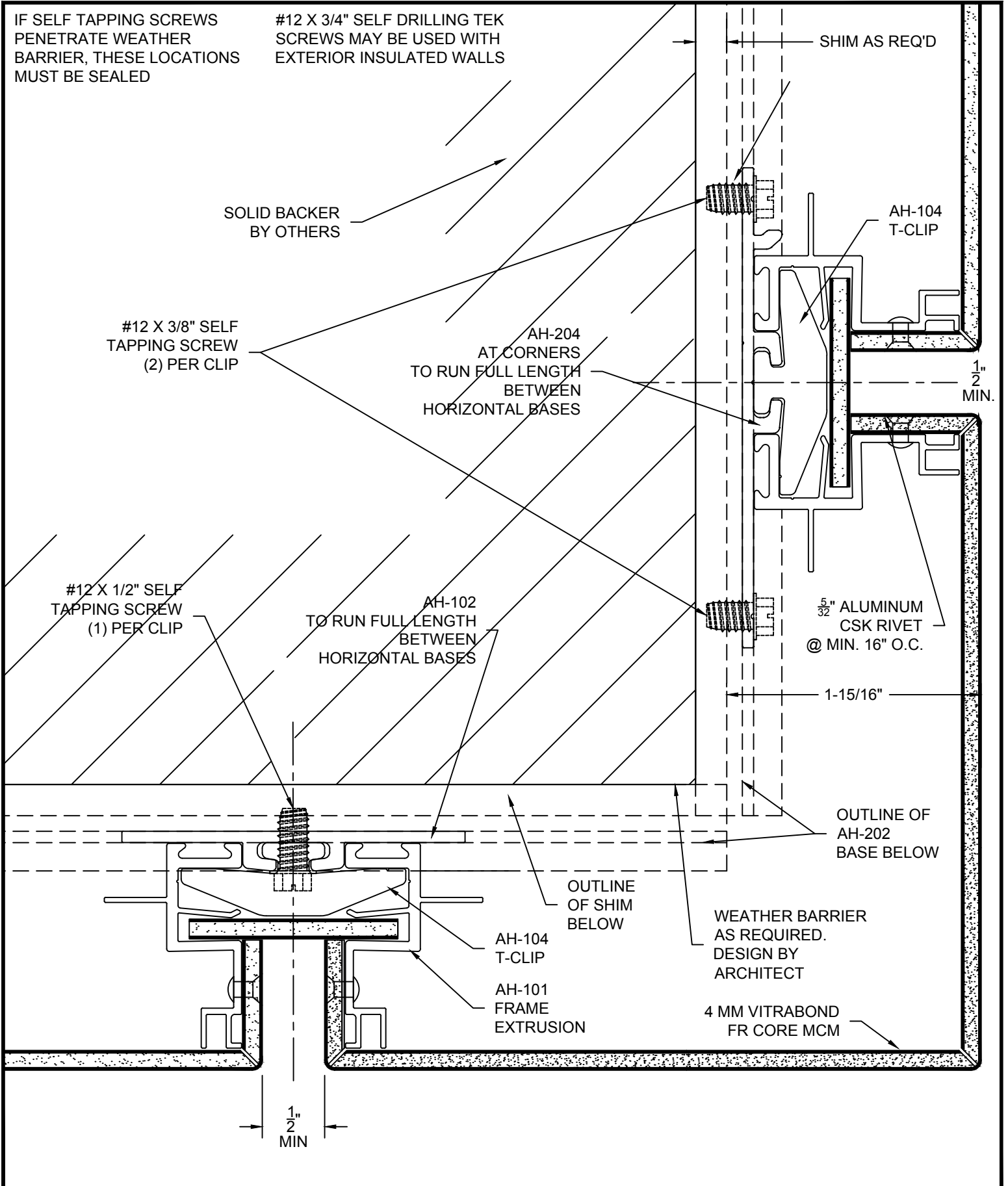

Sheet <b>9</b>	Drawn By NCDS	Project Number  <b>DWG-01</b>	Project  <b>ARROWHEAD RAINSCREEN PANEL SYSTEM OUTSIDE CORNER DETAIL</b>	N\FairView\Refs\Fairview_Logo.JPG
	Date Drawn 2/2/2018		© Copyright Fairview Architectural LLC - Patented and/or Patent Pending	N\FairView\Refs\Arrowhead_Logo.png
	Revisions No. _____ Date _____ No. _____ Date _____			www.fairview-na.com

IF SELF TAPPING SCREWS  
PENETRATE WEATHER  
BARRIER, THESE LOCATIONS  
MUST BE SEALED

#12 X 3/4" SELF DRILLING TEK  
SCREWS MAY BE USED WITH  
EXTERIOR INSULATED WALLS

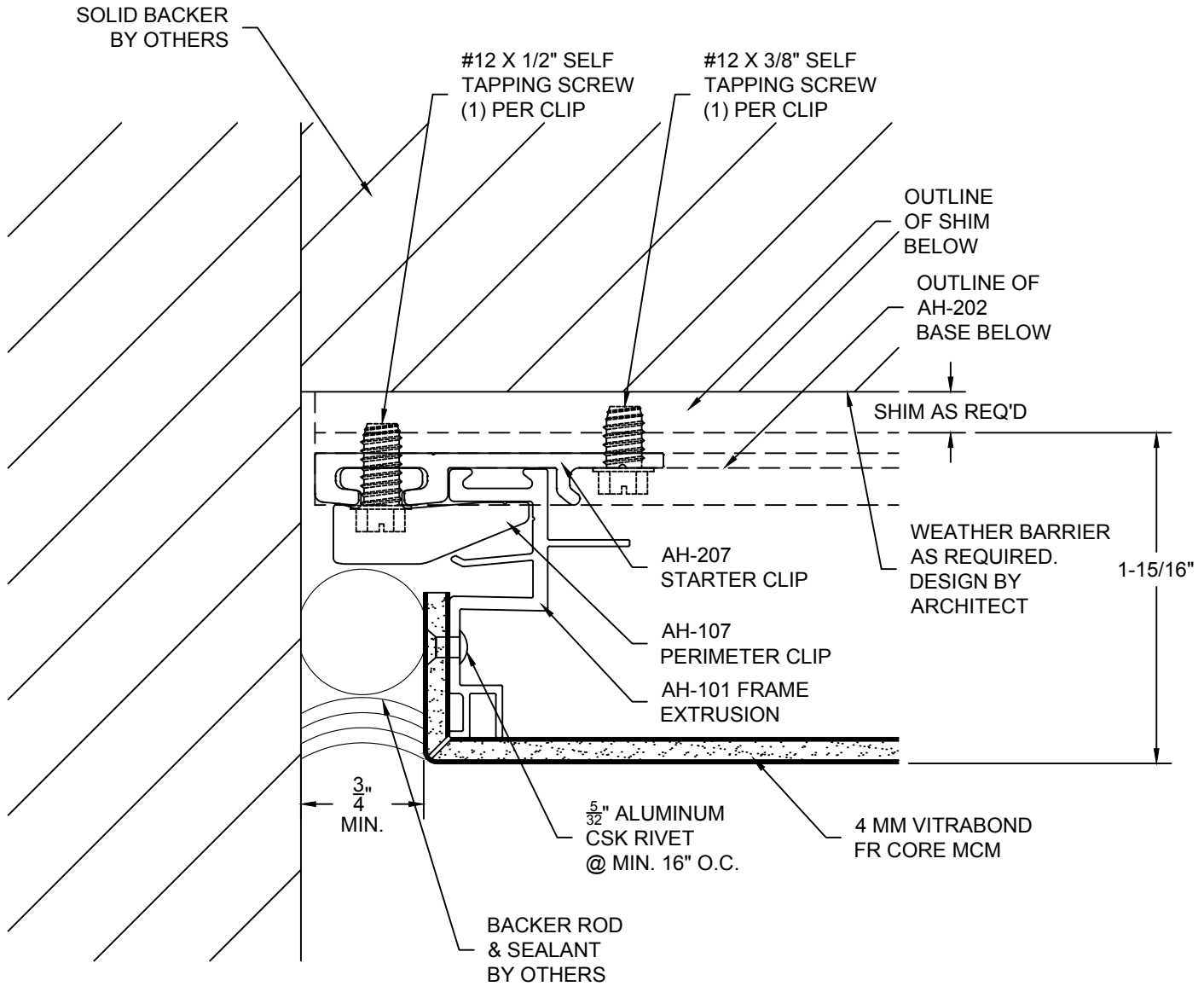

Sheet  <b>10A</b>	Drawn By NCDS	Project Number  <b>DWG-01</b>	Project  <b>ARROWHEAD RAINSCREEN PANEL SYSTEM VERTICAL JAMB DETAIL - START</b>	<small>N\FairView\Refs\Fairview_Logo.JPG</small>
	Date Drawn 2/2/2018		© Copyright Fairview Architectural LLC - Patented and/or Patent Pending	<small>N\FairView\Refs\Arrowhead_Logo.png</small>
	Revisions No. _____ Date _____ No. _____ Date _____		www.fairview-na.com	

IF SELF TAPPING SCREWS  
PENETRATE WEATHER  
BARRIER, THESE LOCATIONS  
MUST BE SEALED

#12 X 3/4" SELF DRILLING TEK  
SCREWS MAY BE USED WITH  
EXTERIOR INSULATED WALLS

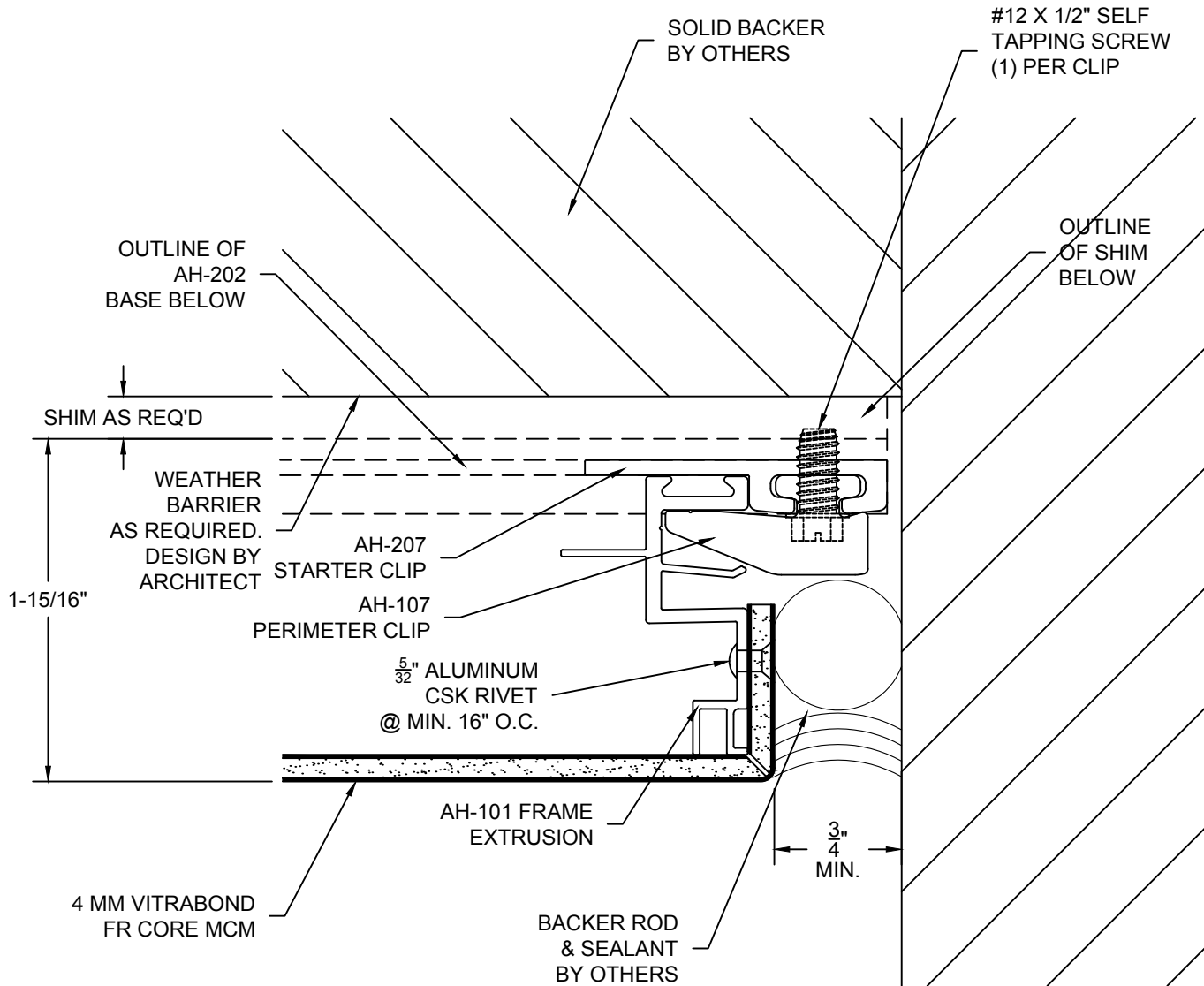

Sheet  <b>10B</b>	Drawn By NCDS	Project Number  <b>DWG-01</b>	Project  <b>ARROWHEAD RAINSCREEN PANEL SYSTEM VERTICAL JAMB DETAIL - END</b>	<small>N\Fair-View\Refs\Fair-view_Logo.JPG</small>  <small>N\Fair-View\Refs\Arrowhead_Logo.png</small>  <small>www.fairview-na.com</small>
	Date Drawn 2/2/2018			
	Revisions No. _____ Date _____ No. _____ Date _____			
© Copyright Fairview Architectural LLC - Patented and/or Patent Pending				

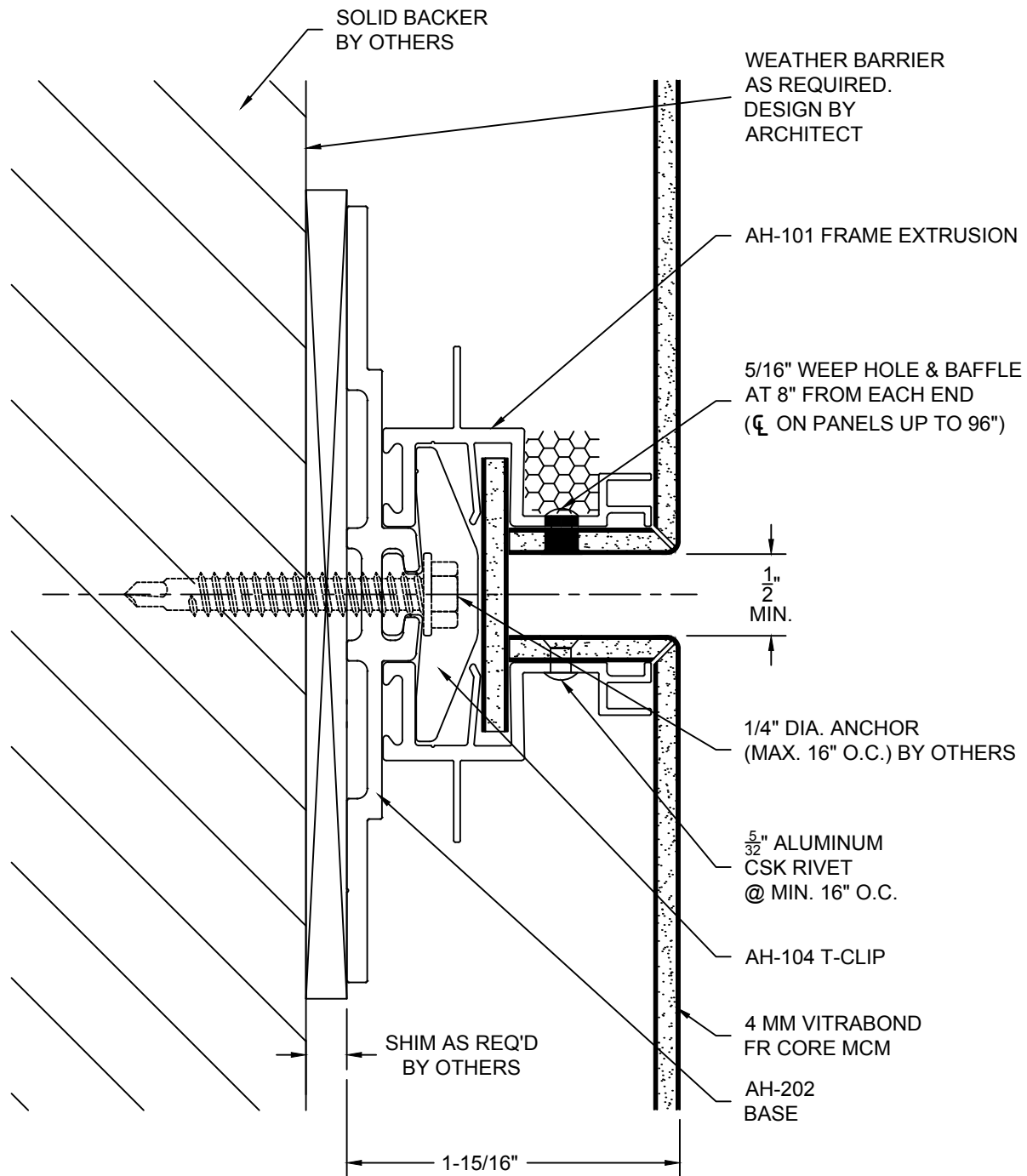

Sheet

11

Drawn By NCDS
Date Drawn 2/2/2018
Revisions
No. _____ Date _____
No. _____ Date _____

Project Number
DWG-01

Project
ARROWHEAD RAINSCREEN PANEL SYSTEM TYPICAL HORIZONTAL DETAIL
© Copyright Fairview Architectural LLC - Patented and/or Patent Pending

N\FairView\Refs\Fairview_Logo.JPG
N\FairView\Refs\Arrowhead_Logo.png
www.fairview-na.com

IF SELF TAPPING SCREWS  
PENETRATE WEATHER  
BARRIER, THESE LOCATIONS  
MUST BE SEALED

#12 X 3/4" SELF DRILLING TEK  
SCREWS MAY BE USED WITH  
EXTERIOR INSULATED WALLS

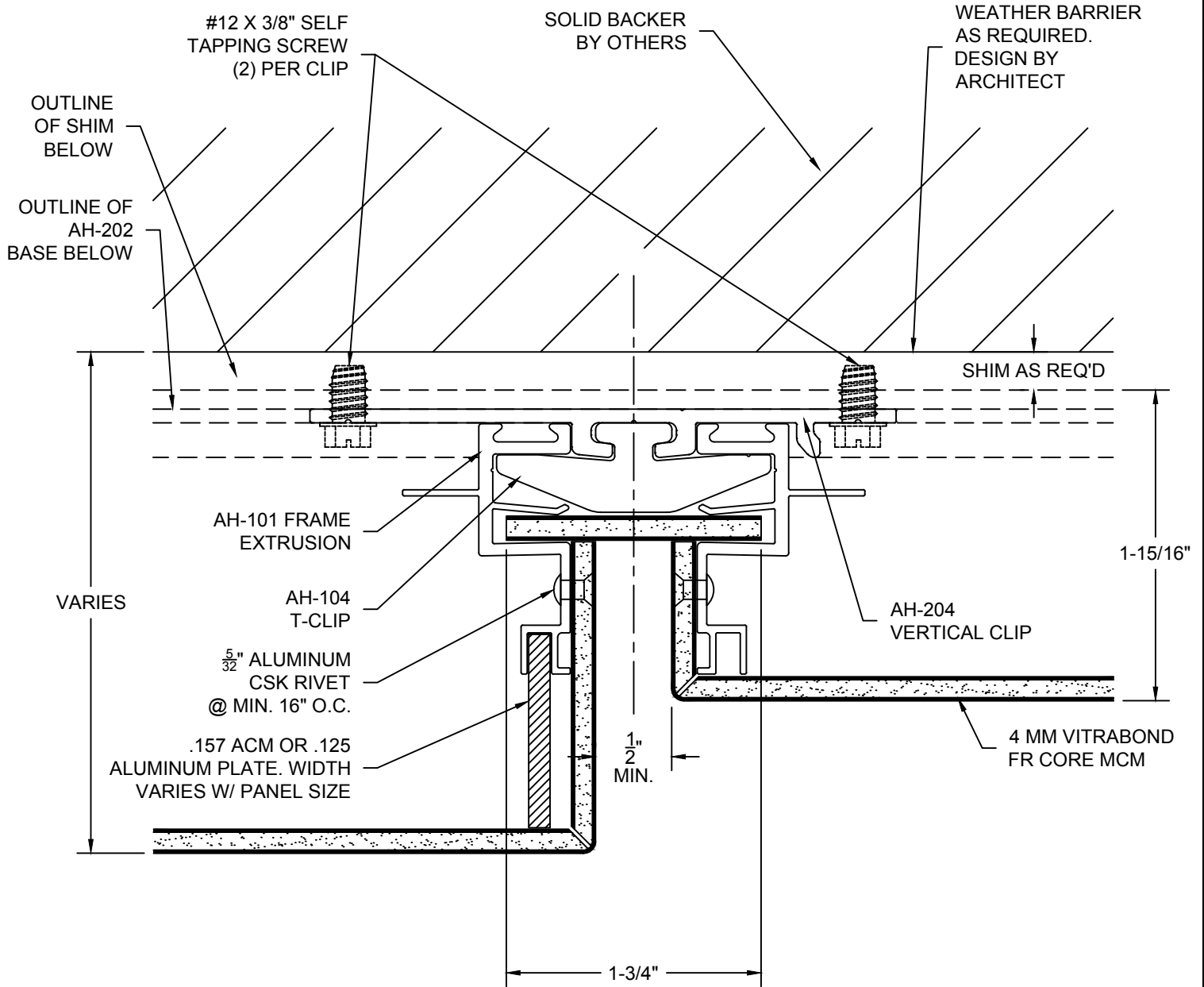

Sheet  <b>12</b>	Drawn By NCDS	Project Number  <b>DWG-01</b>	Project	N:\FairView\Refs\Fairview_Logo.JPG  N:\FairView\Refs\Arrowhead_Logo.png  www.fairview-na.com	
	Date Drawn 2/2/2018		<b>ARROWHEAD RAINSCREEN PANEL SYSTEM</b> <b>DIFF. DEPTH VERTICAL DETAIL</b>		
	Revisions		© Copyright Fairview Architectural LLC - Patented and/or Patent Pending		
	No. _____ Date _____ No. _____ Date _____				

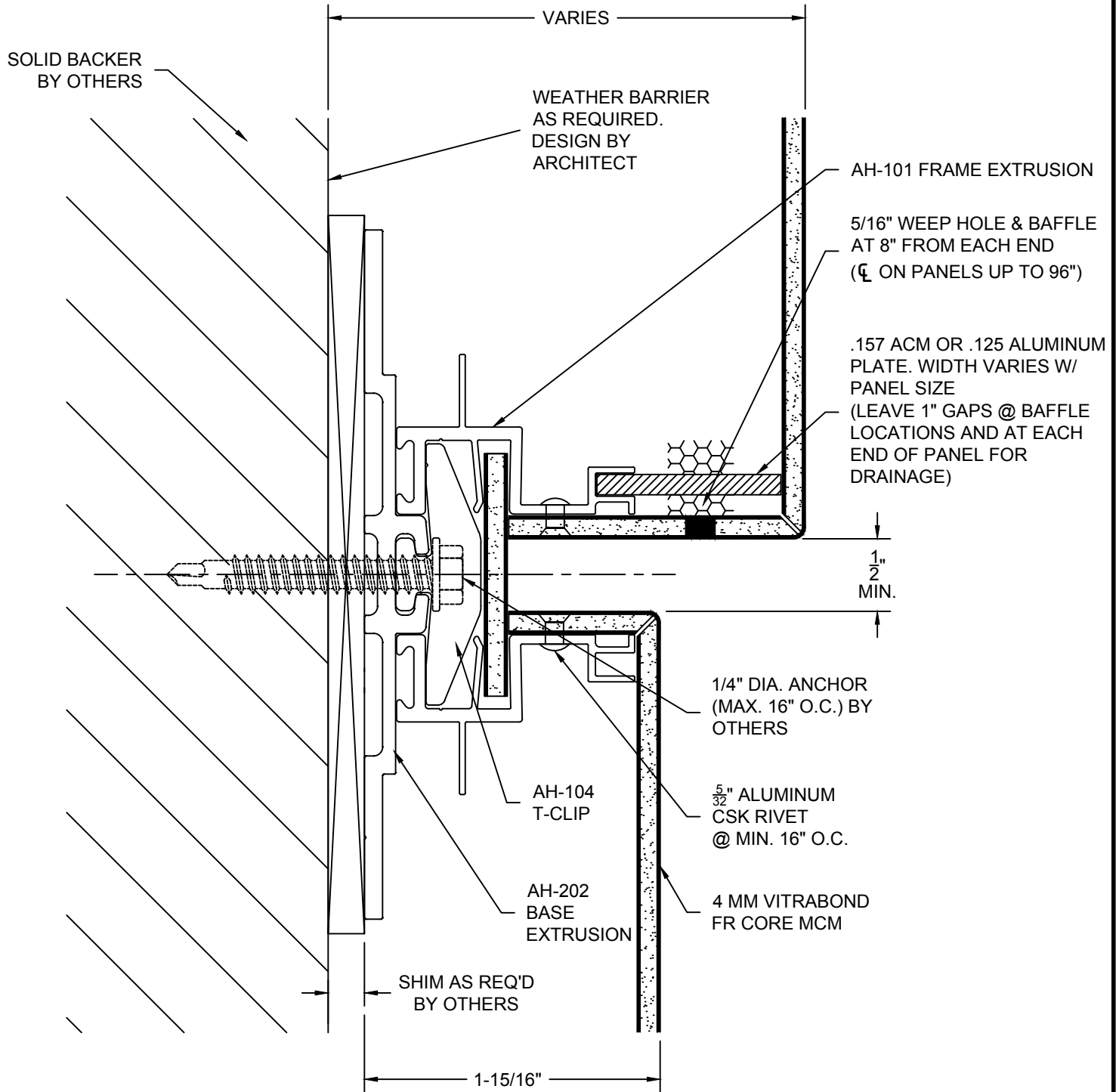

Sheet  <b>13</b>	Drawn By <b>NCDS</b>	Project Number  <b>DWG-01</b>	Project  <b>ARROWHEAD RAINSCREEN PANEL SYSTEM DIFF. DEPTH HORIZONTAL DETAIL</b>	N\FairView\Refs\Fairview_Logo.JPG		
	Date Drawn 2/2/2018				N\FairView\Refs\Arrowhead_Logo.png	
	Revisions No. _____ Date _____ No. _____ Date _____					
	© Copyright Fairview Architectural LLC - Patented and/or Patent Pending			www.fairview-na.com		



IF SELF TAPPING SCREWS  
PENETRATE WEATHER  
BARRIER, THESE LOCATIONS  
MUST BE SEALED

#12 X 3/4" SELF DRILLING TEK  
SCREWS MAY BE USED WITH  
EXTERIOR INSULATED WALLS

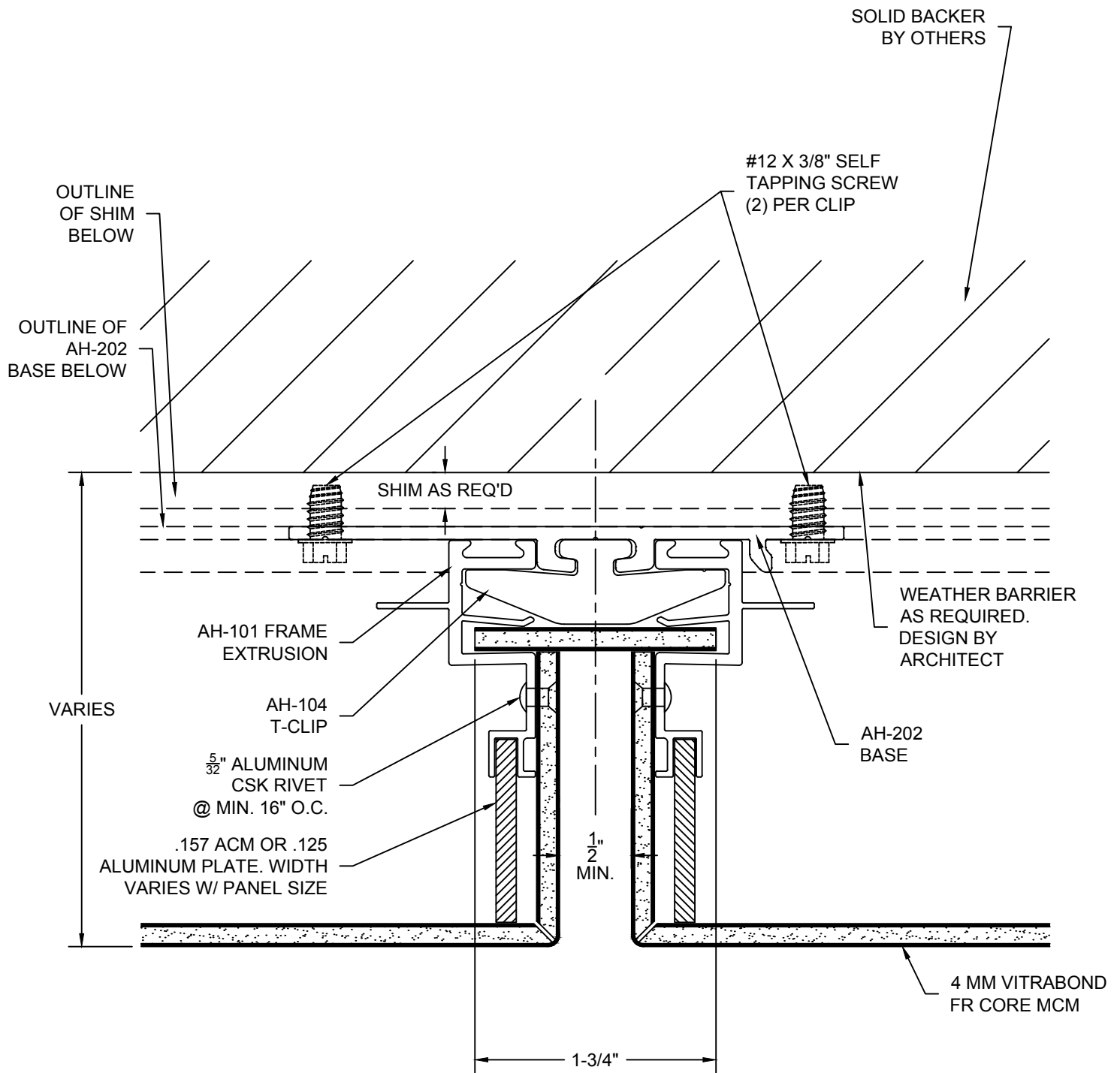

Sheet <b>14</b>	Drawn By NCDS	Project Number  <b>DWG-01</b>	Project	N\FairView\Refs\Fairview_Logo.JPG  N\FairView\Refs\Arrowhead_Logo.png  www.fairview-na.com
	Date Drawn 2/2/2018		<b>ARROWHEAD RAINSCREEN PANEL SYSTEM</b>	
	Revisions No. _____ Date _____ No. _____ Date _____		<b>DIFF. DEPTH VERTICAL DETAIL</b>	
			© Copyright Fairview Architectural LLC - Patented and/or Patent Pending	

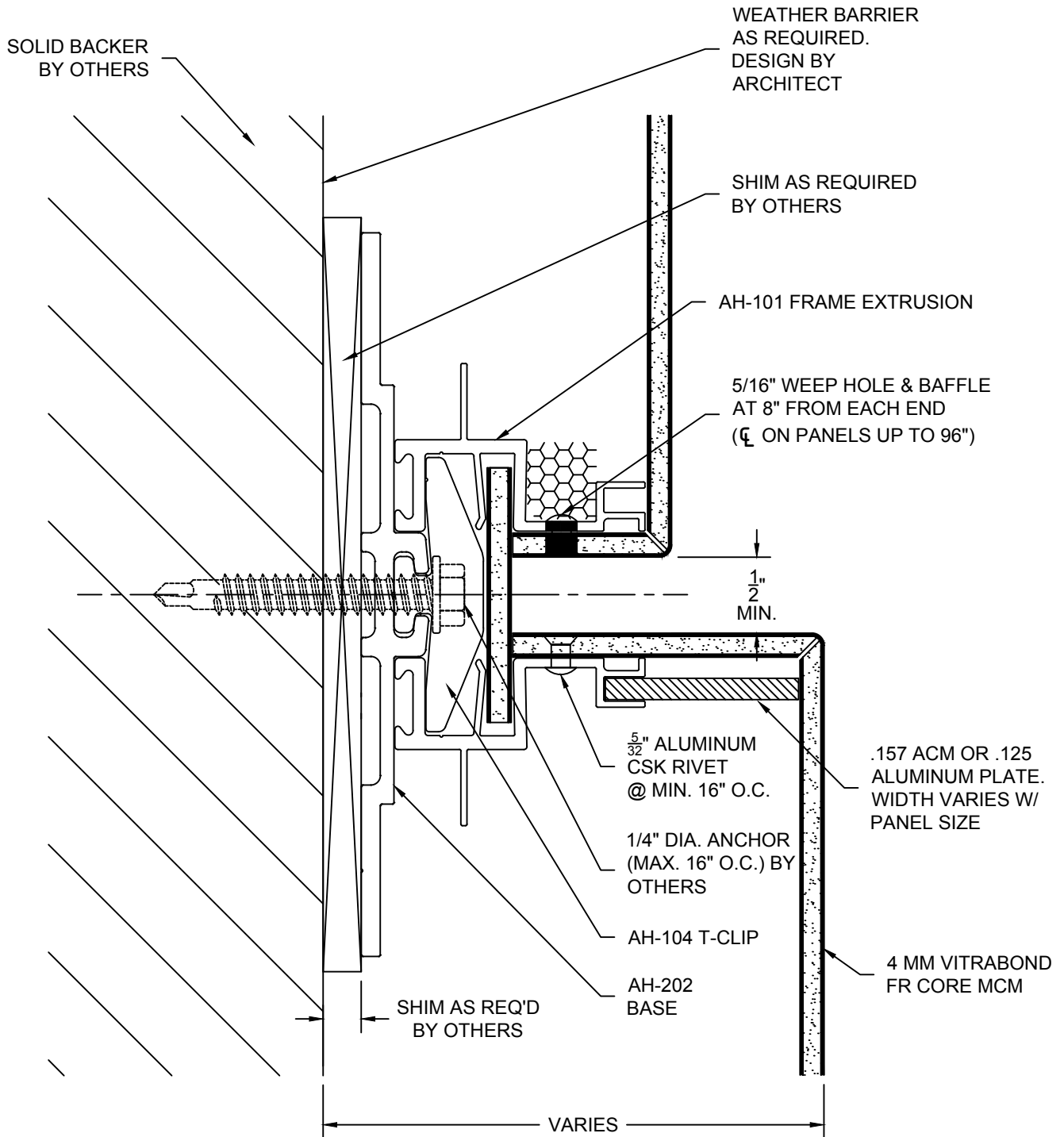

Sheet  <b>15</b>	Drawn By <b>NCDS</b>	Project Number  <b>DWG-01</b>	Project  <b>ARROWHEAD RAINSCREEN PANEL SYSTEM DIFF. DEPTH HORIZONTAL DETAIL</b>	N\FairView\Refs\Fairview_Logo.JPG  N\FairView\Refs\Arrowhead_Logo.png  www.fairview-na.com
	Date Drawn 2/2/2018			
	Revisions No. _____ Date _____ No. _____ Date _____			
	© Copyright Fairview Architectural LLC - Patented and/or Patent Pending			

IF SELF TAPPING SCREWS  
PENETRATE WEATHER  
BARRIER, THESE LOCATIONS  
MUST BE SEALED

#12 X 3/4" SELF DRILLING TEK  
SCREWS MAY BE USED WITH  
EXTERIOR INSULATED WALLS

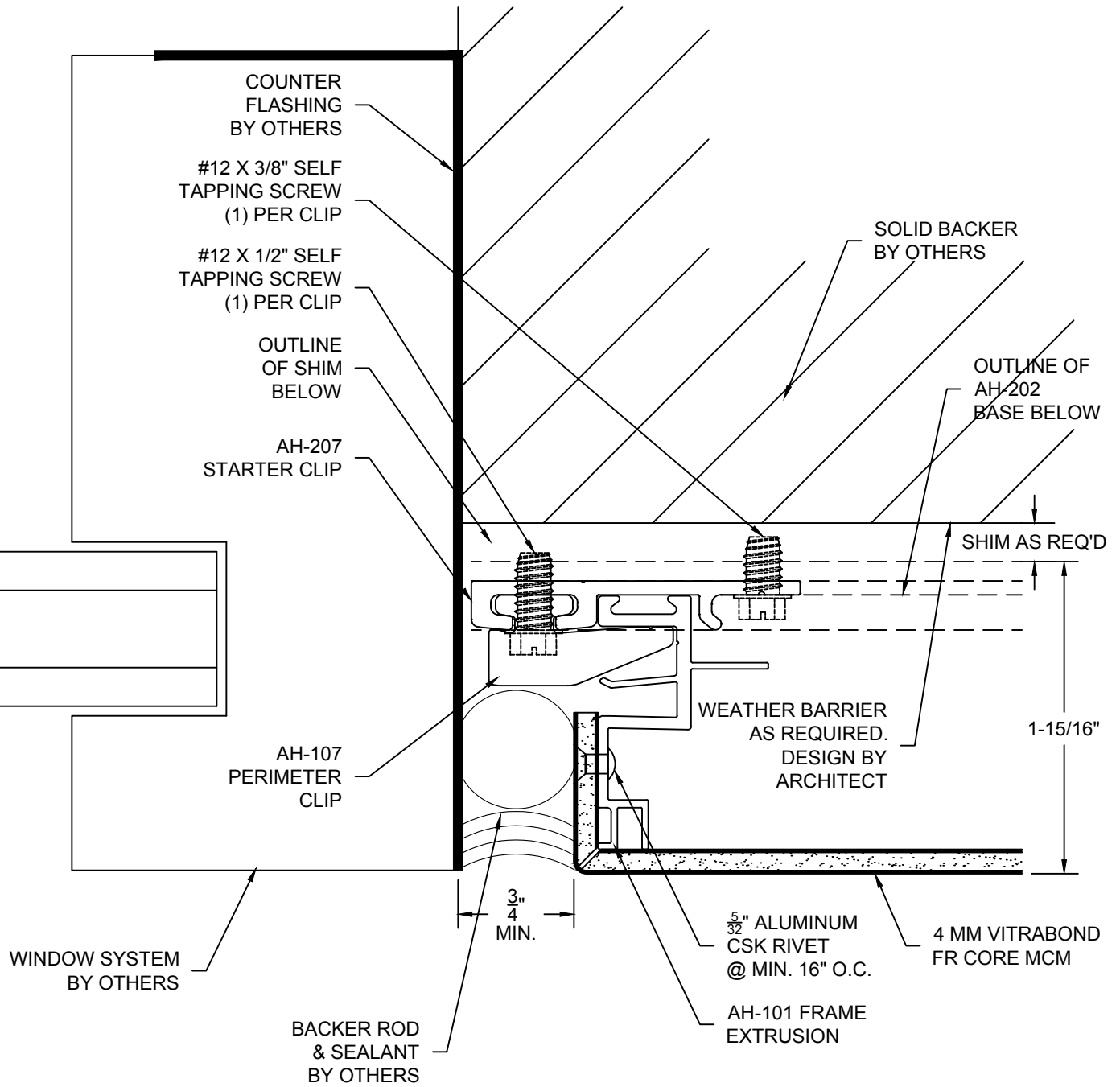

Sheet  <b>16</b>	Drawn By NCDS	Project Number  <b>DWG-01</b>	Project	<a href="#">N\FairView\Refs\Fairview_Logo.JPG</a>  <a href="#">N\FairView\Refs\Arrowhead_Logo.png</a>  <a href="http://www.fairview-na.com">www.fairview-na.com</a>
	Date Drawn 2/2/2018		<b>ARROWHEAD RAINSCREEN PANEL SYSTEM</b>	
	Revisions		<b>DISSIMILAR METALS - JAMB</b>	
	No. _____ Date _____ No. _____ Date _____		© Copyright Fairview Architectural LLC - Patented and/or Patent Pending	

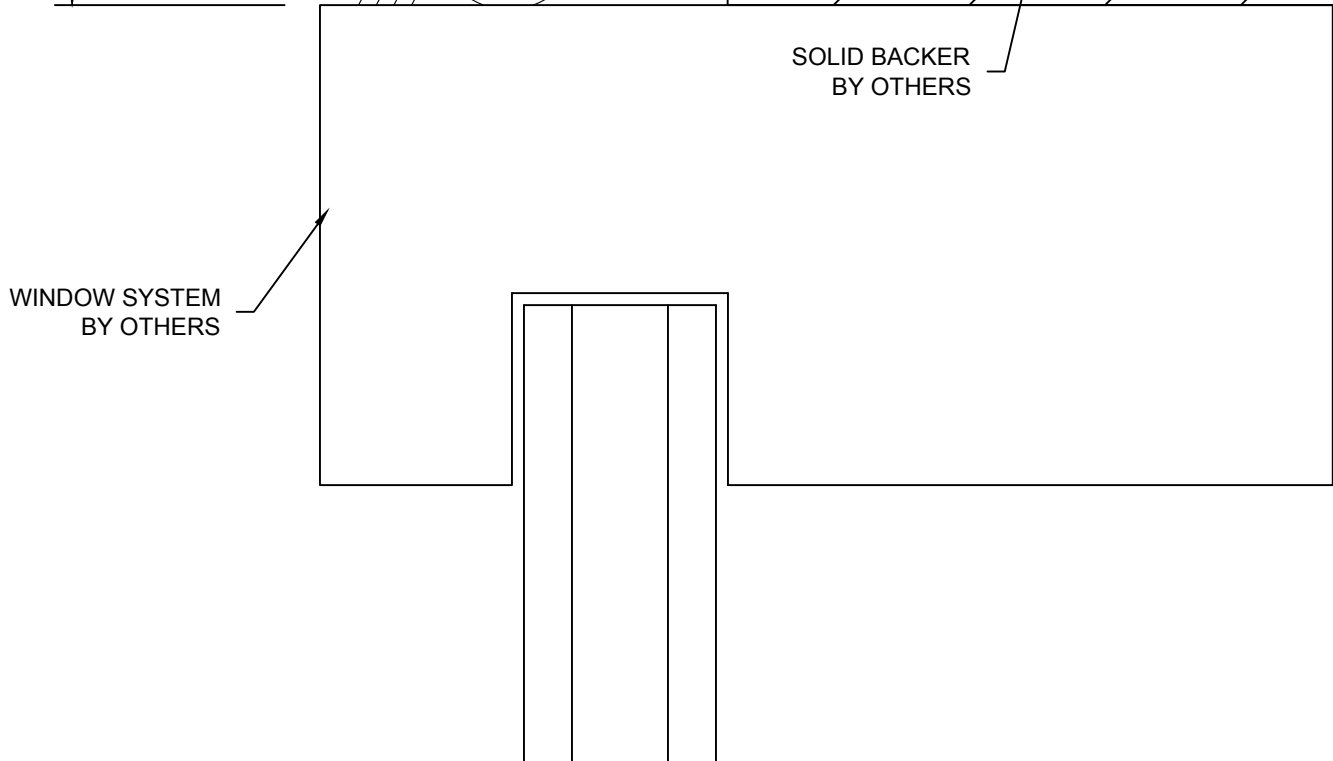
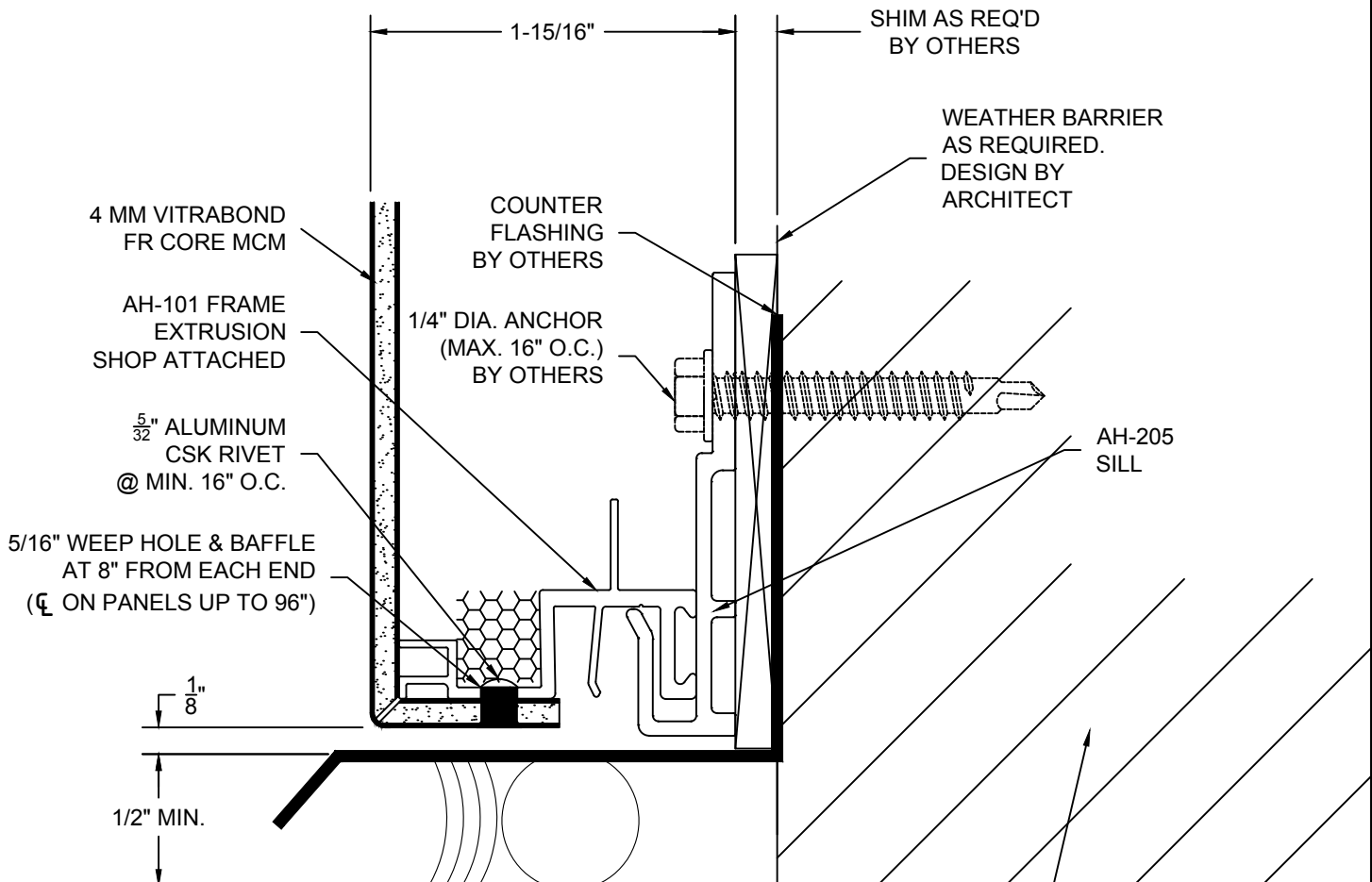

Sheet  <b>17</b>	Drawn By <b>NCDS</b>	Project Number  <b>DWG-01</b>	Project  <b>ARROWHEAD RAINSCREEN PANEL SYSTEM DISSIMILAR METALS - SILL</b>	N:\Fair-View\Refs\Fair-view_Logo.JPG  N:\Fair-View\Refs\Arrowhead_Logo.png  www.fairview-na.com
	Date Drawn 2/2/2018			
	Revisions No. _____ Date _____ No. _____ Date _____			
© Copyright Fairview Architectural LLC - Patented and/or Patent Pending				

IF SELF TAPPING SCREWS  
PENETRATE WEATHER  
BARRIER, THESE LOCATIONS  
MUST BE SEALED

#12 X 3/4" SELF DRILLING TEK  
SCREWS MAY BE USED WITH  
EXTERIOR INSULATED WALLS

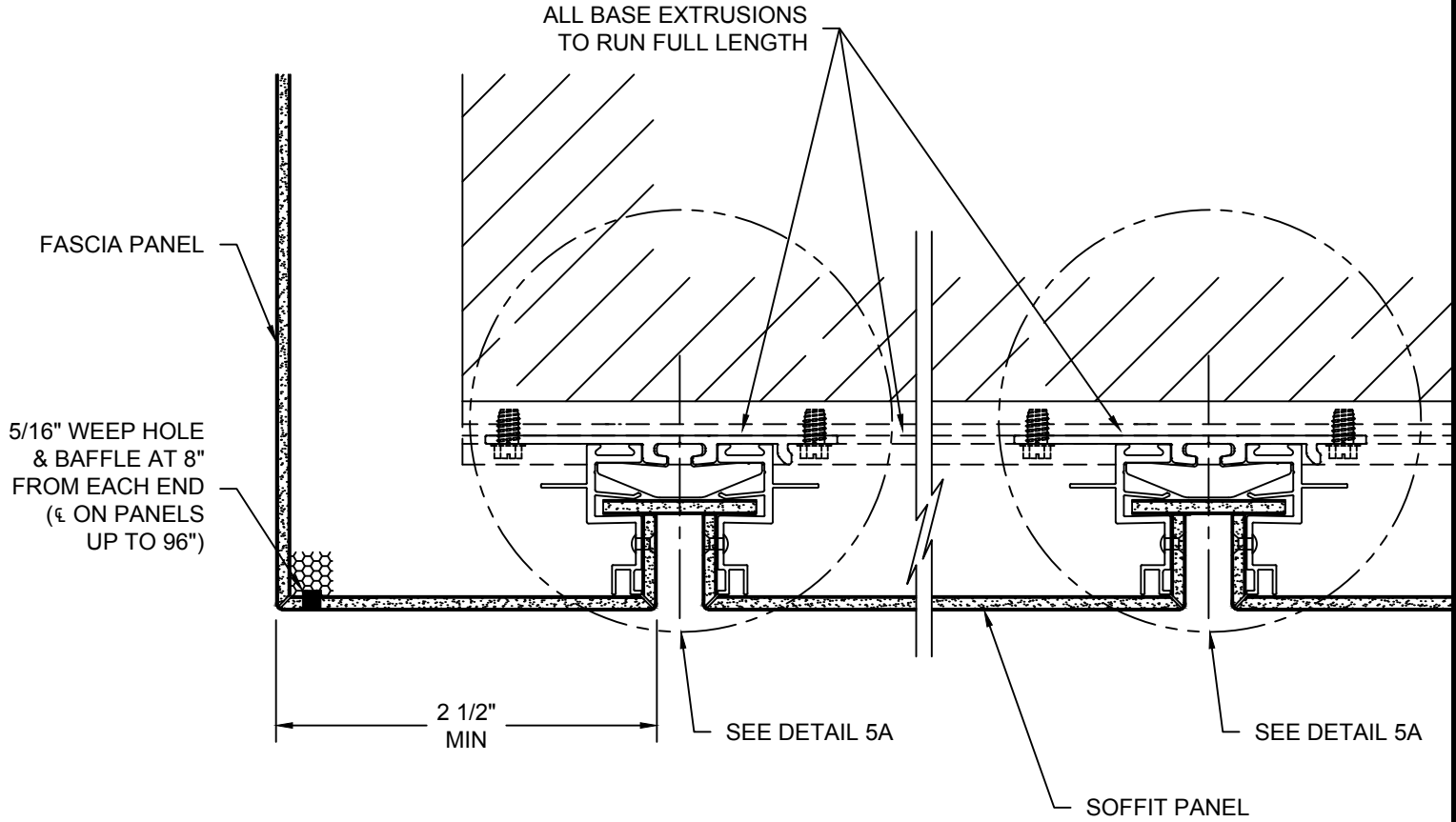

Sheet  <b>18</b>	Drawn By NCDS	Project Number  <b>DWG-01</b>	Project	N\FairView\Refs\Fairview_Logo.JPG  N\FairView\Refs\Arrowhead_Logo.png  www.fairview-na.com
	Date Drawn 2/2/2018		<b>ARROWHEAD RAINSCREEN PANEL SYSTEM</b> <b>TYPICAL SOFFIT DETAIL</b>	
	Revisions No. _____ Date _____ No. _____ Date _____		© Copyright Fairview Architectural LLC - Patented and/or Patent Pending	

IF SELF TAPPING SCREWS  
PENETRATE WEATHER  
BARRIER, THESE LOCATIONS  
MUST BE SEALED

#12 X 3/4" SELF DRILLING TEK  
SCREWS MAY BE USED WITH  
EXTERIOR INSULATED WALLS

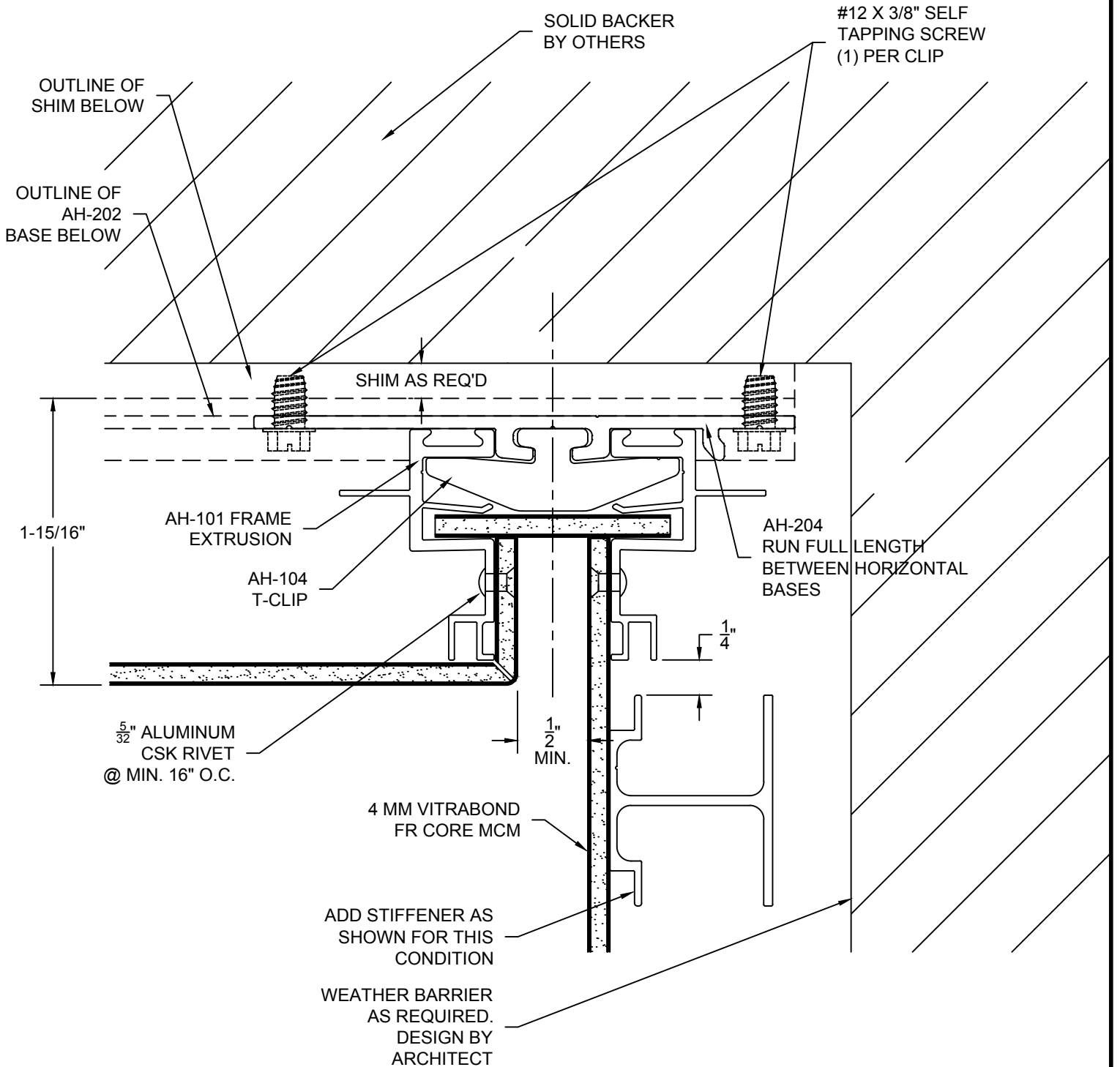

Sheet  <b>19</b>	Drawn By NCDS	Project Number  <b>DWG-01</b>	Project	N:\FairView\Refs\Fairview_Logo.JPG  N:\FairView\Refs\Arrowhead_Logo.png  www.fairview-na.com	
	Date Drawn 2/2/2018		<b>ARROWHEAD RAINSCREEN PANEL SYSTEM</b> <b>SOFFIT TO WALL DETAIL</b>		
	Revisions				© Copyright Fairview Architectural LLC - Patented and/or Patent Pending
	No. _____ Date _____ No. _____ Date _____				